

# すいたん (吹田市のキャラクター)

渡辺眞寿美：創作

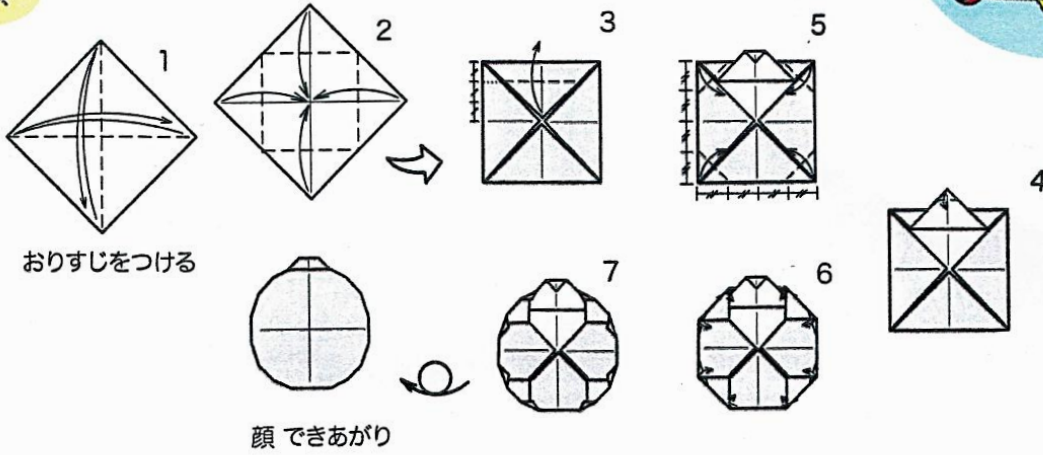

## 顔



## 服

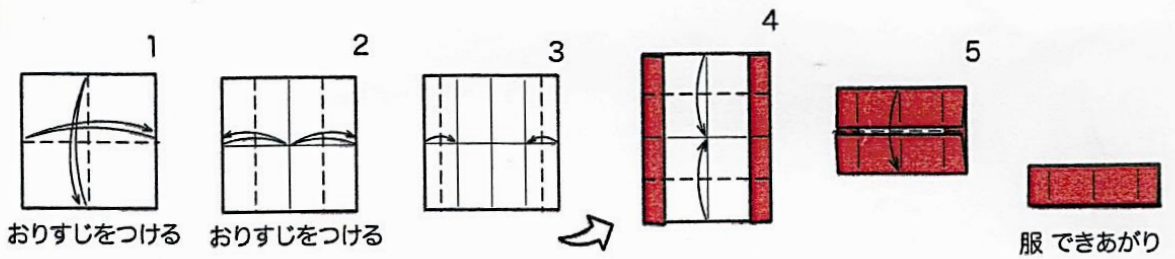

## 手

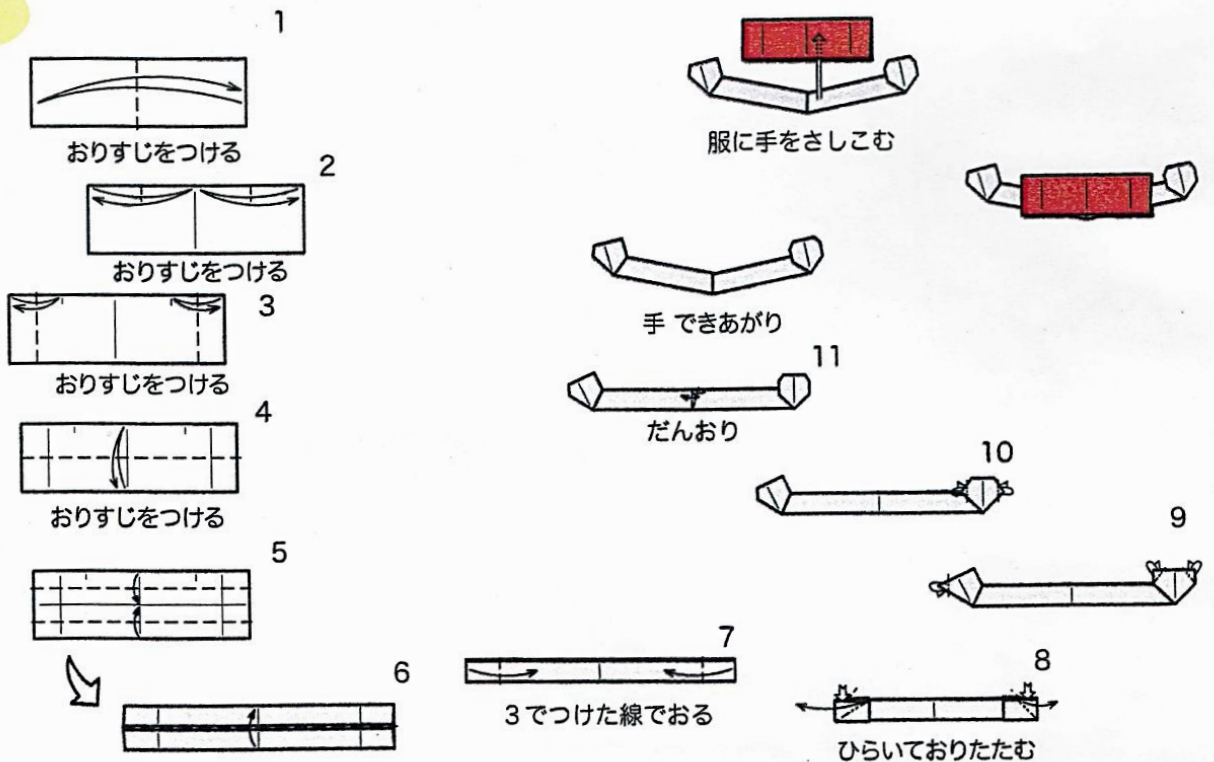

つ리즈ボン

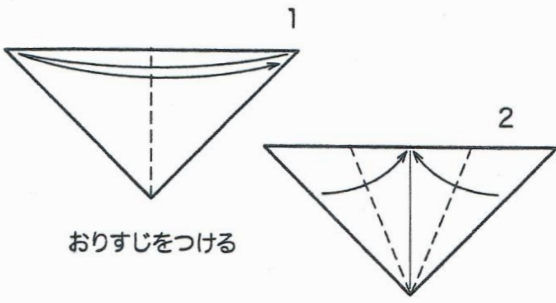

おりすじをつける

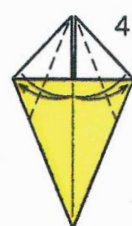
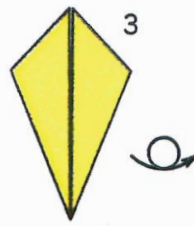

おりすじをつける

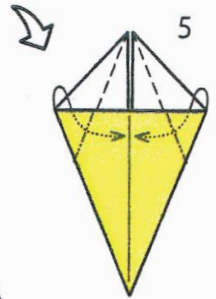

なかわりおり

2枚  
いっしょに  
おる

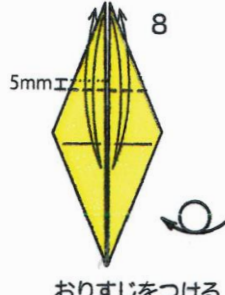

おりすじをつける



5mm

おりすじをつける



手前の2枚だけ  
切りこみをいれる

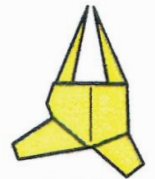

できあがり

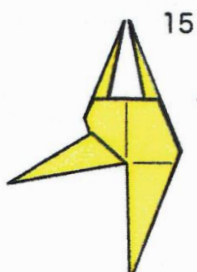
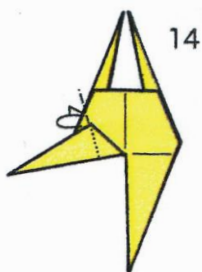
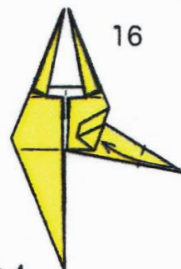
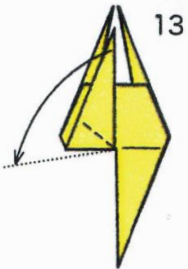

5mm

ハート

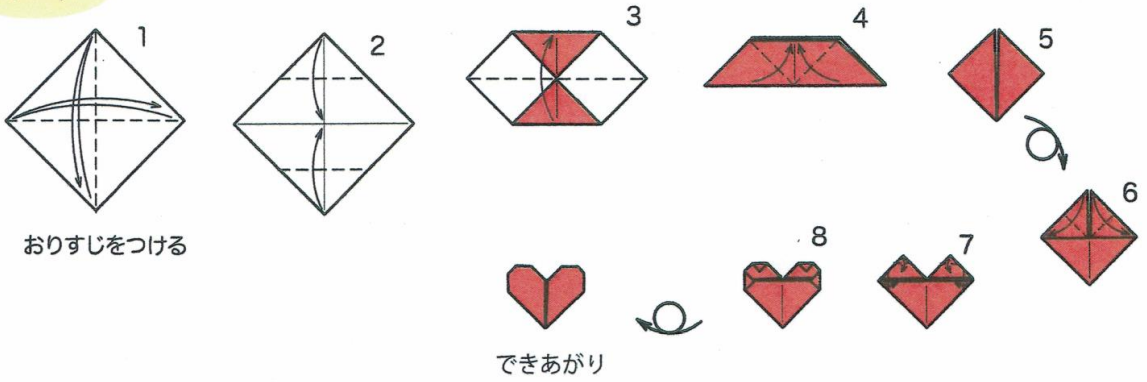

花

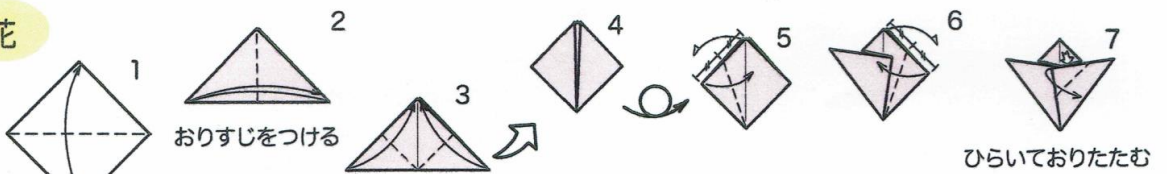

がく

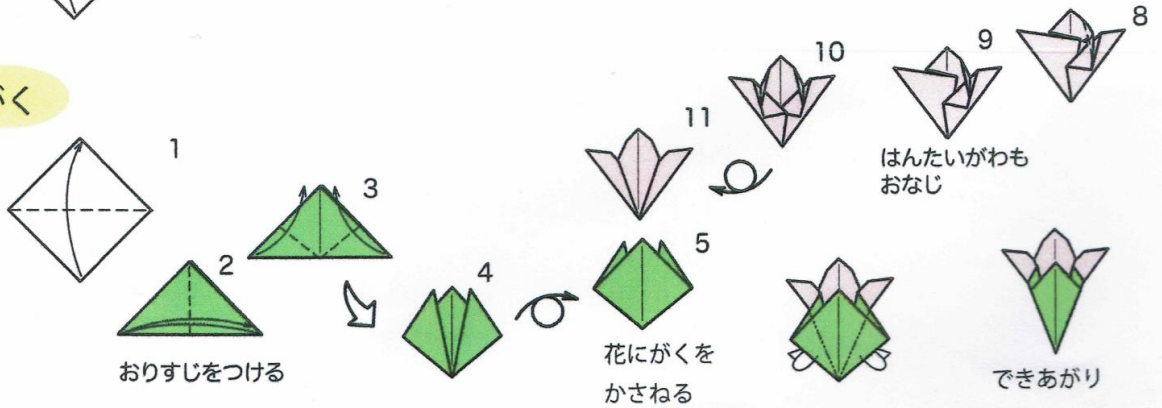

くわいの葉

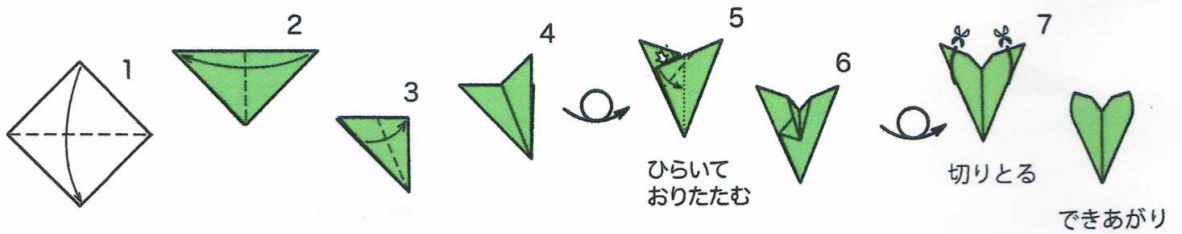

くわいの芽

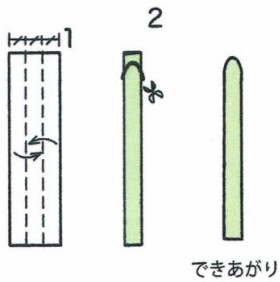

くわいの花

直径 5mm の白い丸シール 3 枚  
直径 3mm の緑の丸シール 1 枚  
をはりあわせる



すいたん 実物大

折った部品を  
このように  
はりあわせましょう

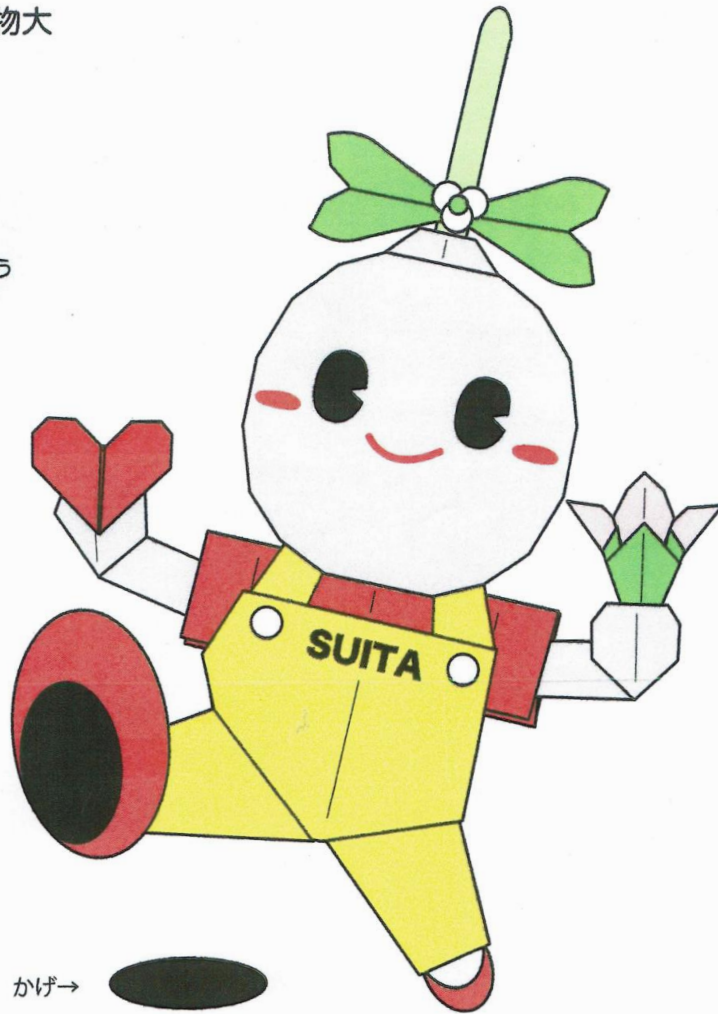

♡ 使用する紙の大きさ ♡

- つりズボン = 15cm × 15cm  
の半分の三角形
- 顔 = 7.5cm × 7.5cm
- 服 = 7.5cm × 7.5cm
- 手 = 12cm × 3.75cm
- ハート = 3.75cm × 3.75cm
- 花 = 3cm × 3cm
- がく = 3cm × 3cm
- くわいの芽 = 7.5cm × 2cm
- くわいの葉 = 3cm × 3cm

くつ

右足

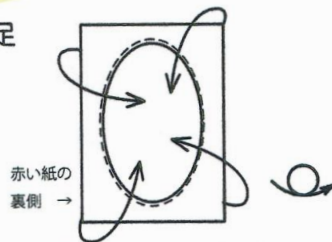

赤い紙にはってくるむ

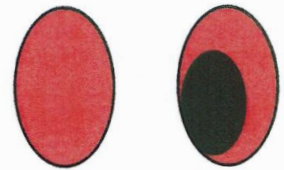

くつ底をはる

左足

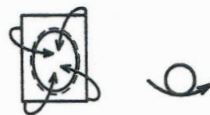

赤い紙にはってくるむ



グレーの紙を  
ずらしてはる