

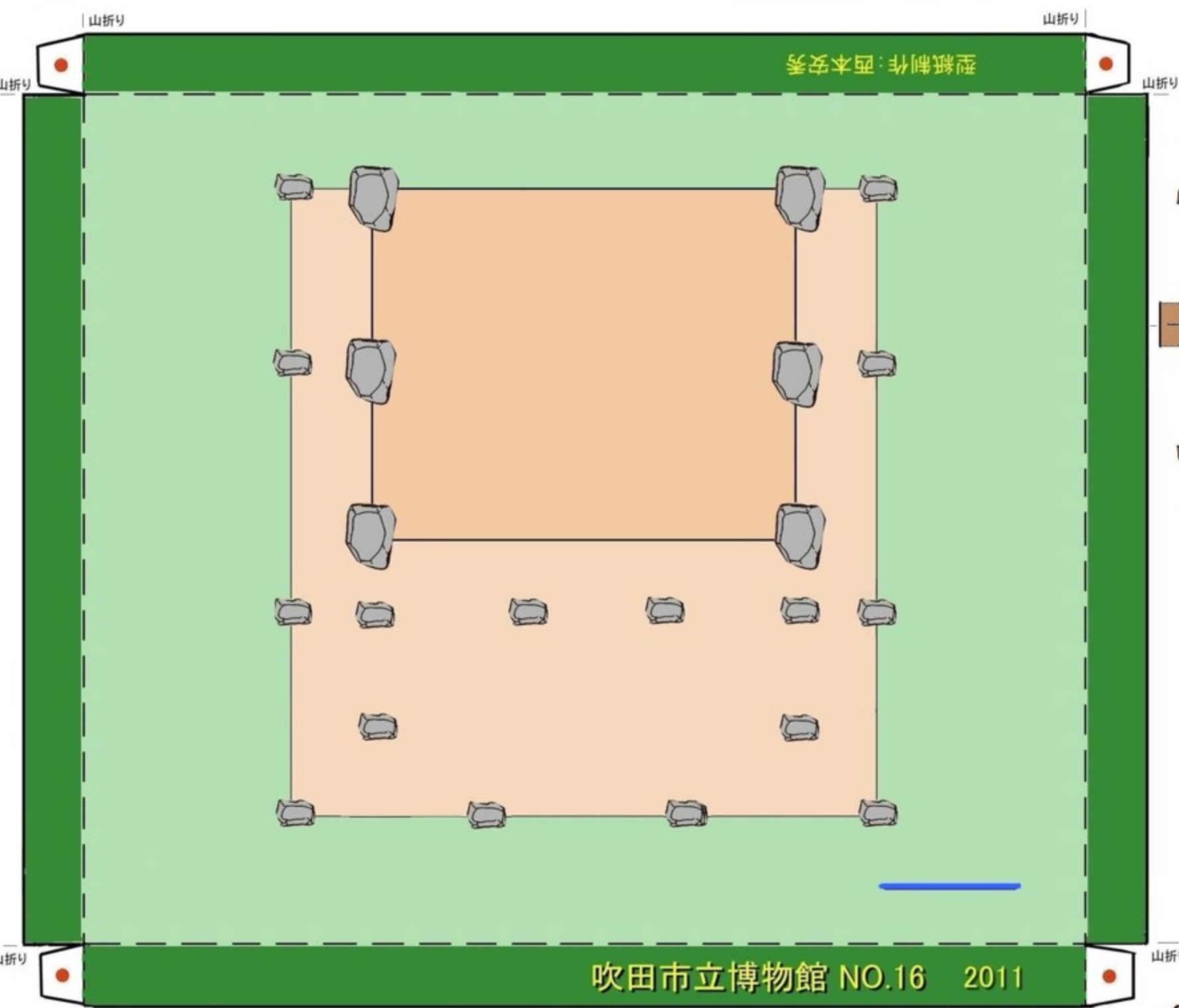

<完成写真>

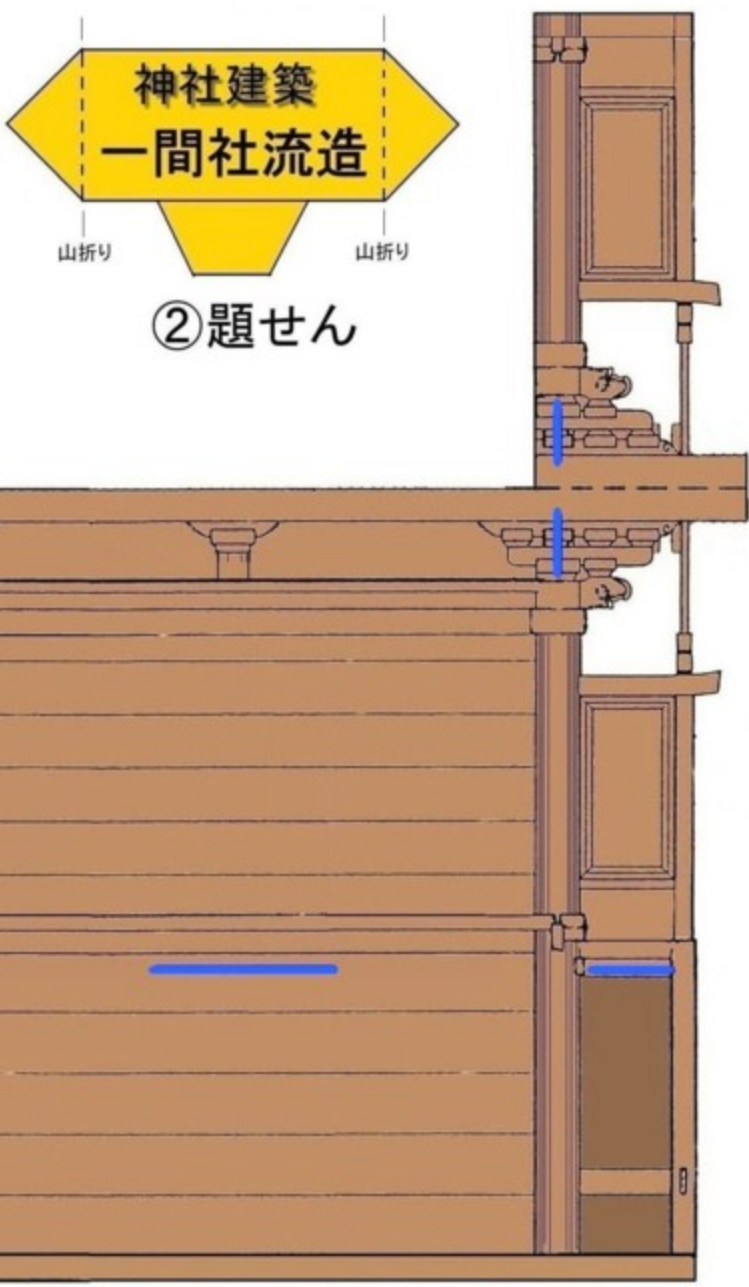

①土台



③背面

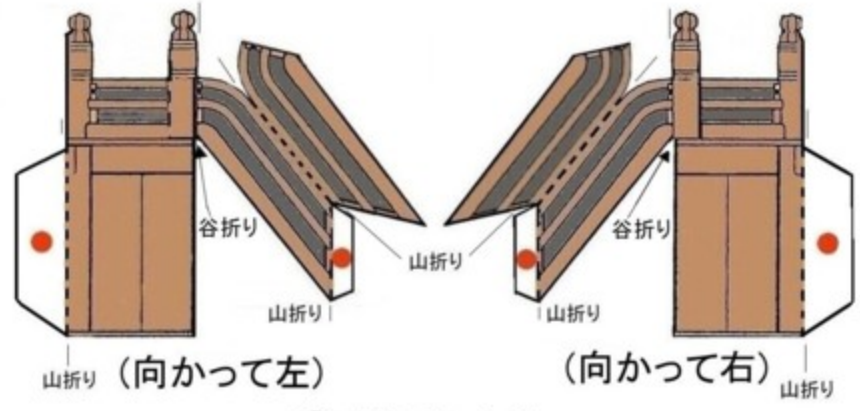

④階手すり

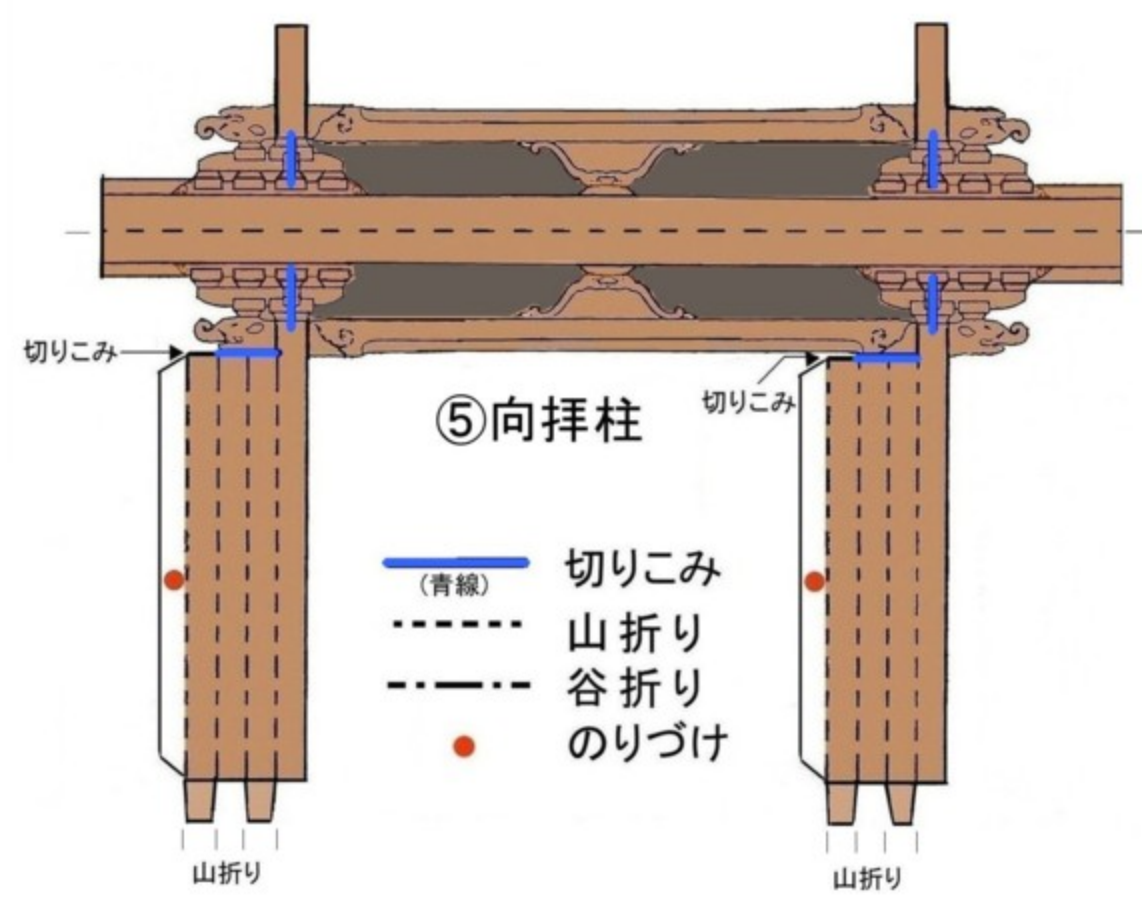

⑤向拝柱

- (青線) 切りこみ
- 山折り
- 谷折りのりづけ

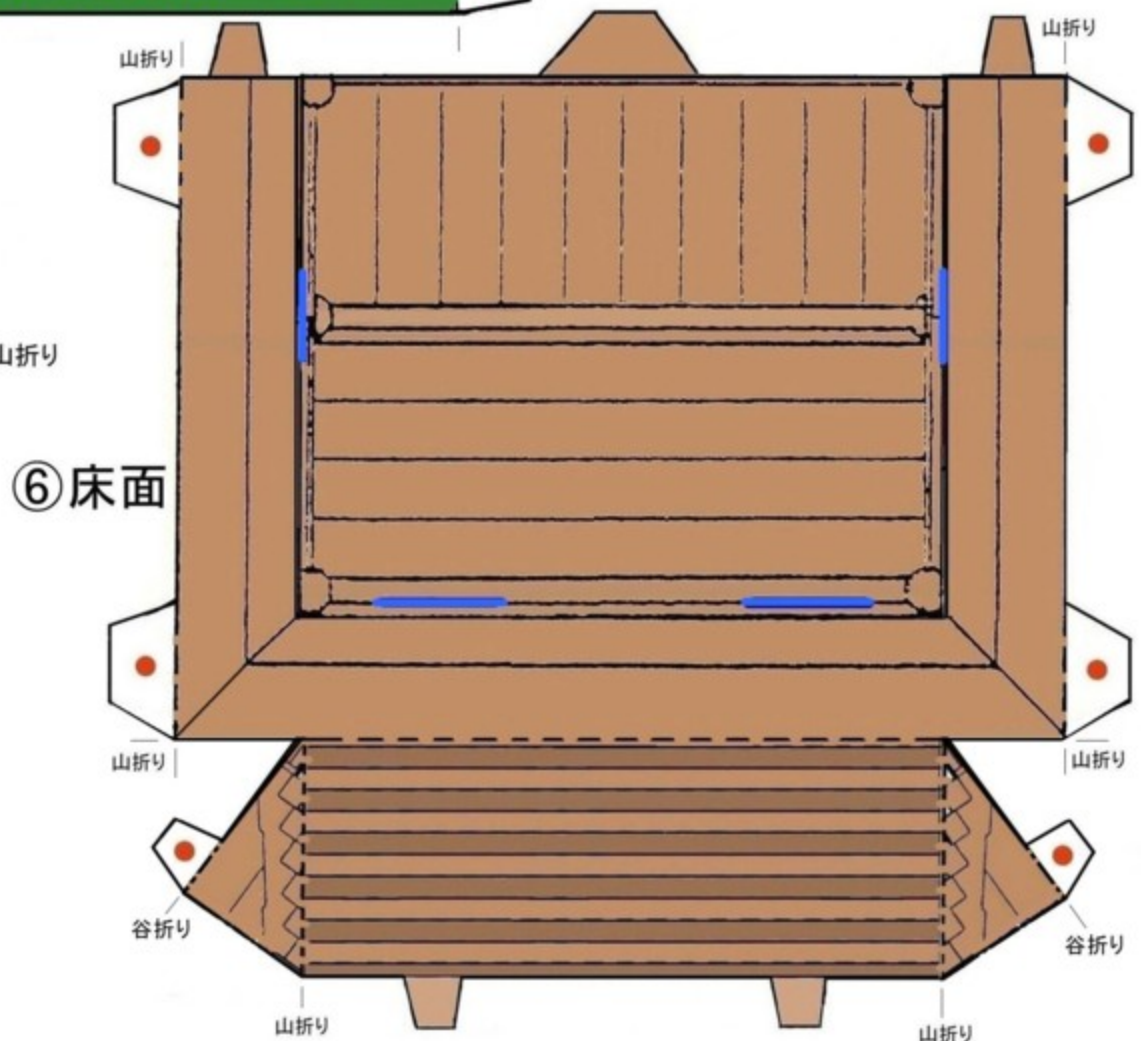

⑥床面

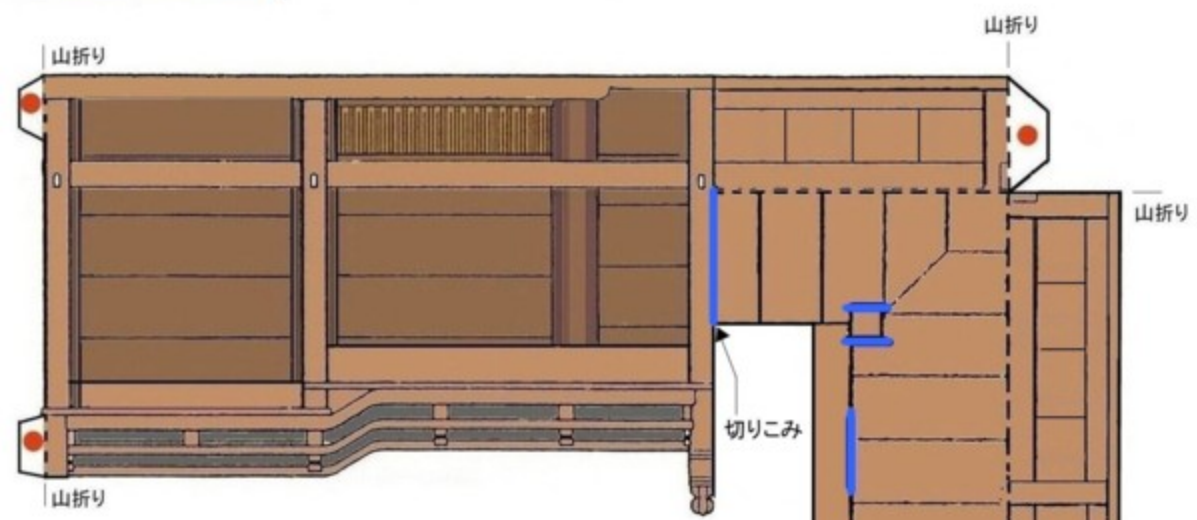

⑦浜床

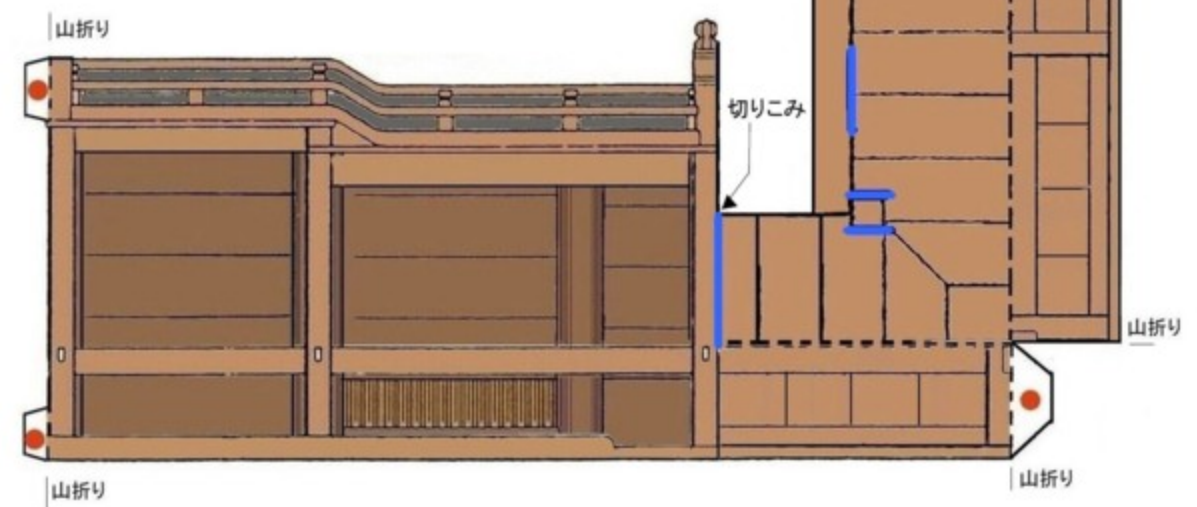

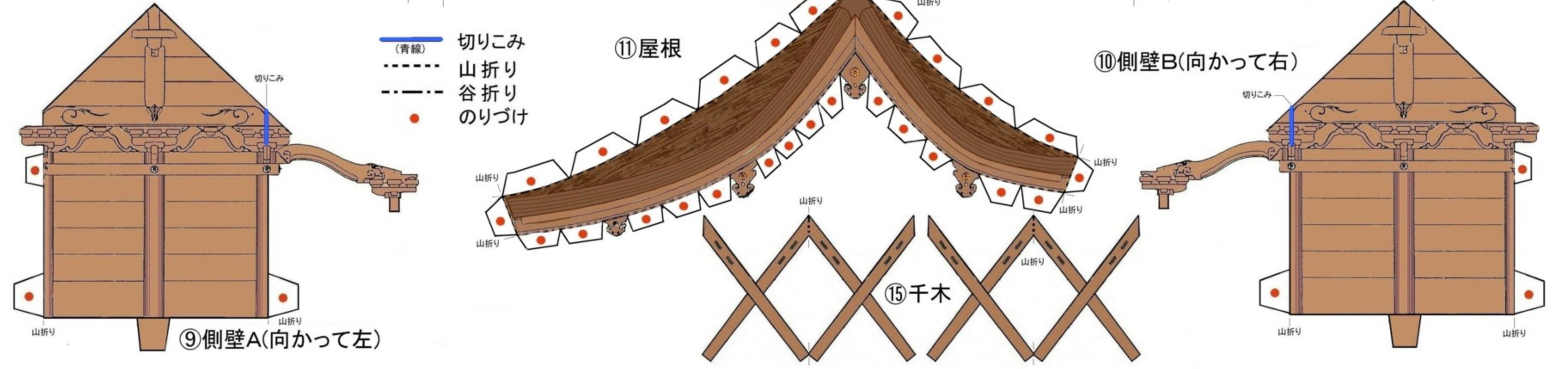
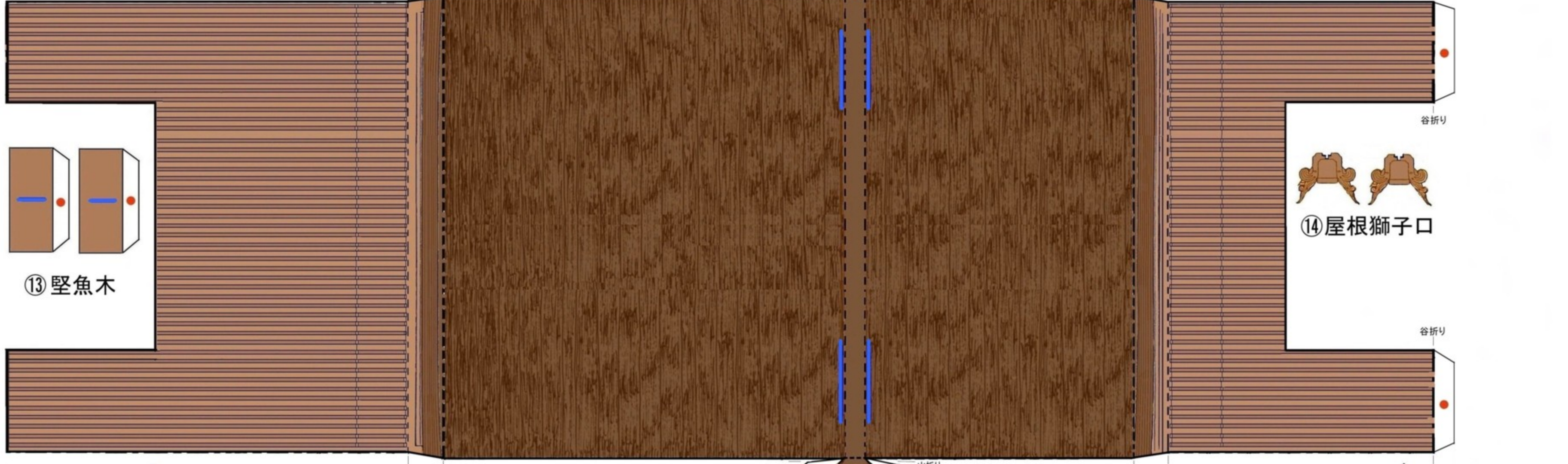
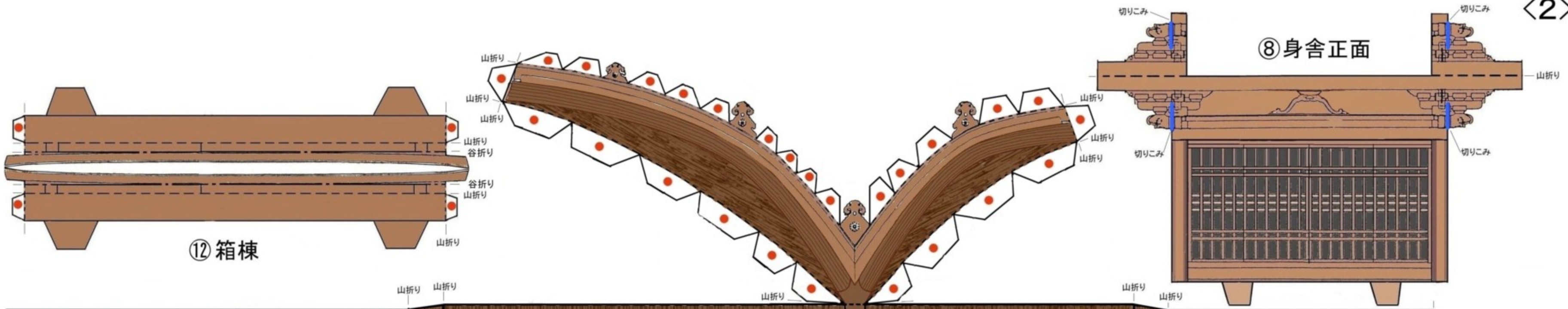

『神社建築 一間社流造』の組み立て方

吹田市立博物館 NO.16 2011

<1 各部品を作る>

*各部品にきりこみを入れてから切りぬく。

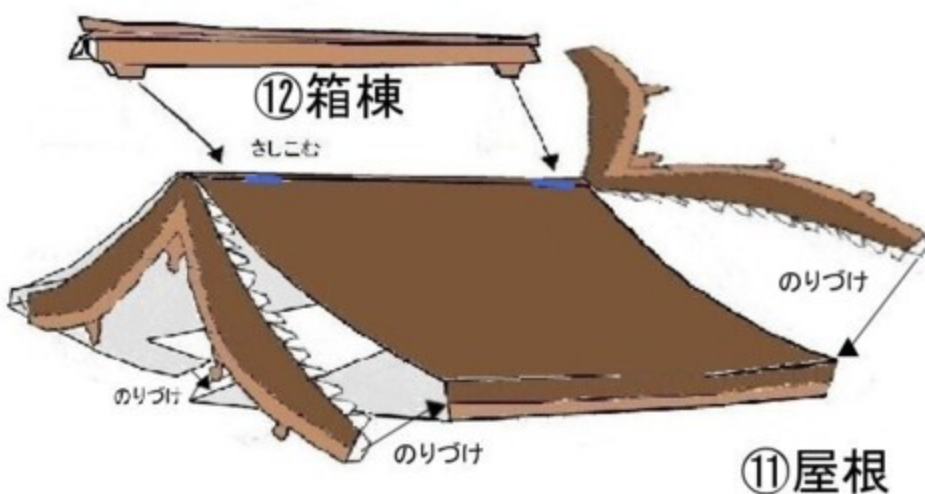
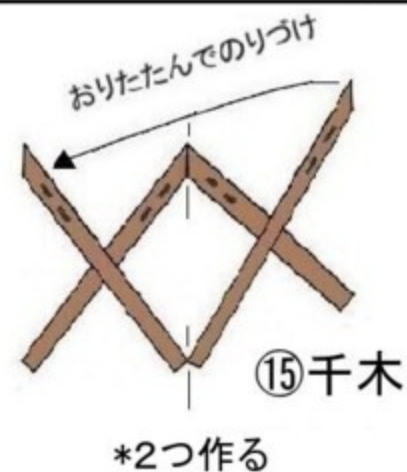
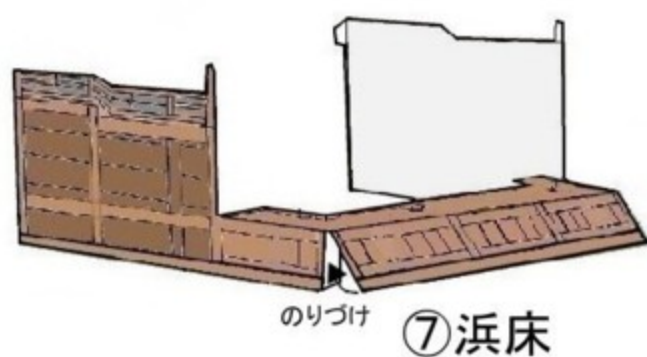
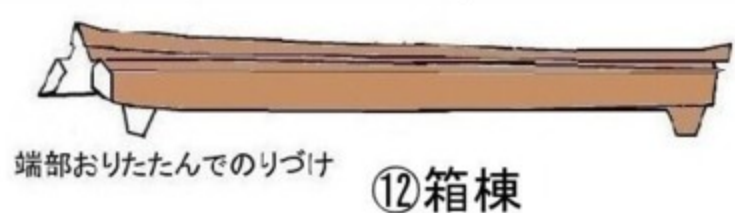
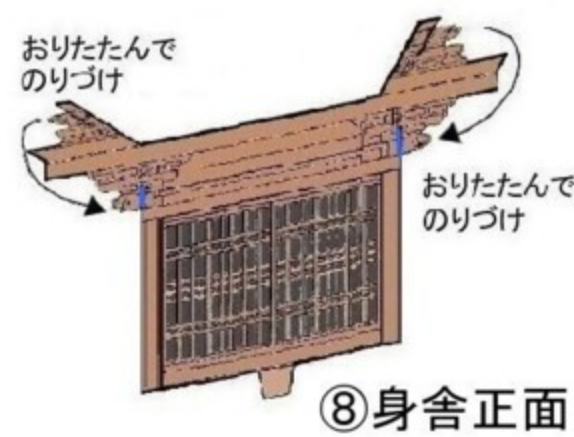
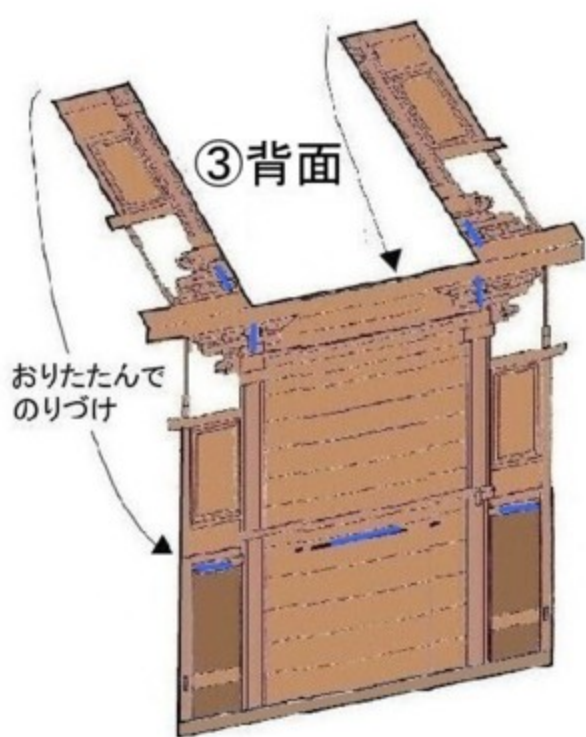
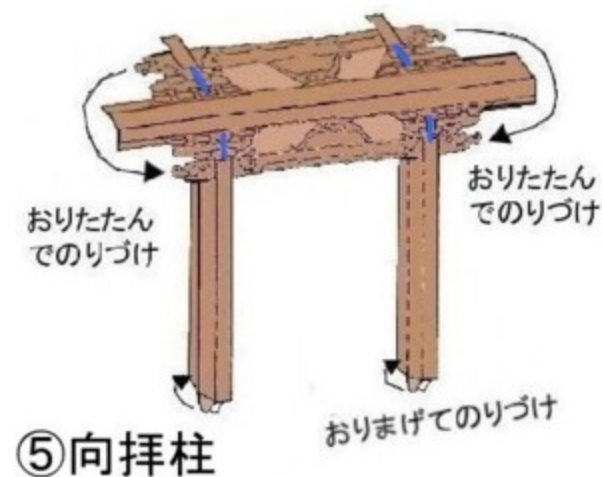
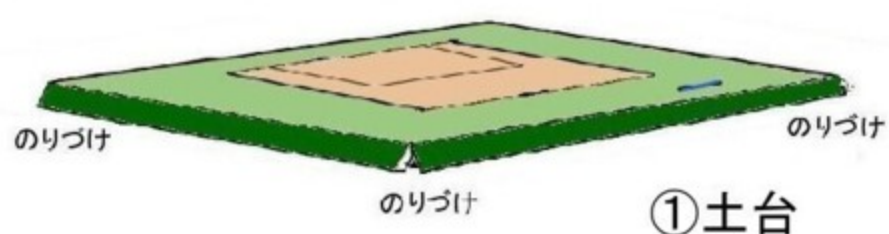

⑪屋根は折り曲げてのりづけし、組み立てる。次に⑫箱棟をさしこむ。

<2 部品を組み立てる>

⑥床面を③背面(うら)にさしこむ。

⑨側壁A、⑩側壁Bを⑥床面及び③背面にさしこむ。

⑧身舎正面を⑥床面、⑨側壁A及び⑩側壁Bにさしこむ。

⑦浜床を③背面(うら)にのりづけし、⑥床面にさしこむ。

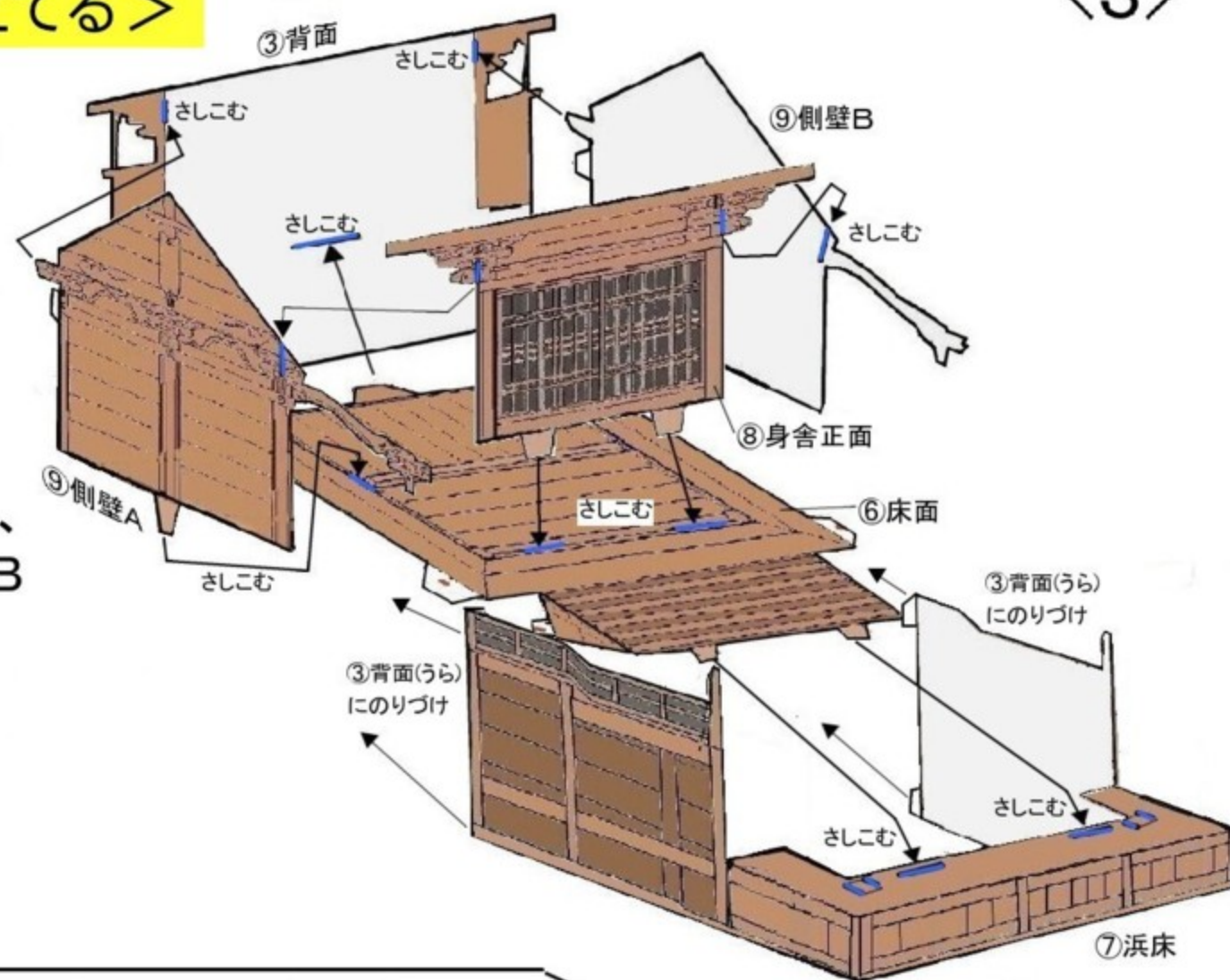

本体に④階手すりをのりづけする。

⑧向拝柱を本体にさしこむ。

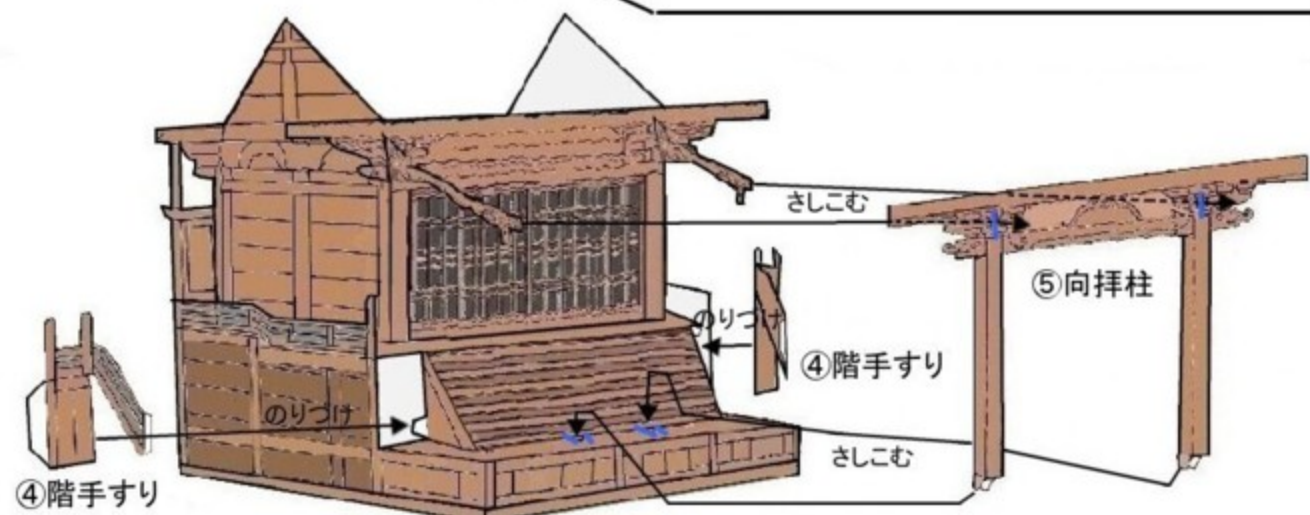

本体に⑪屋根をのせ、⑬堅魚木、⑭屋根獅子口、⑮千木をのりづけし、最後に②題せんをさしこんで完成。

