

井戸 ペーパークラフト-1

吹田市立博物館 NO. 8 2007. 12

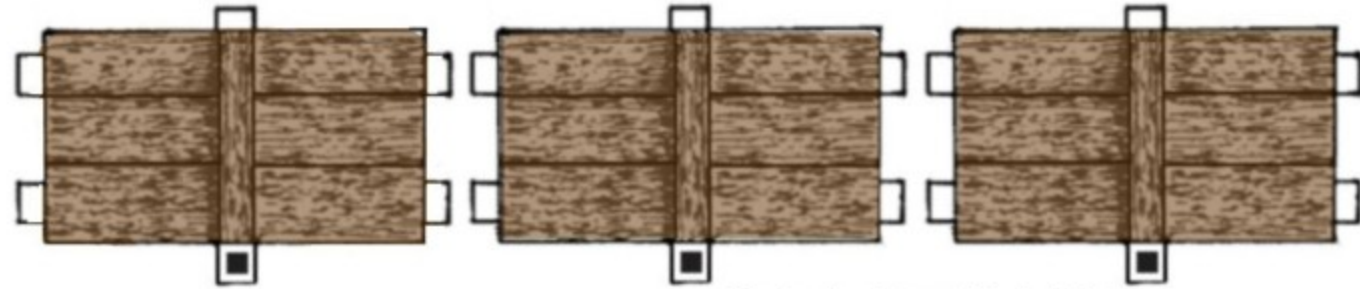

<完成写真>

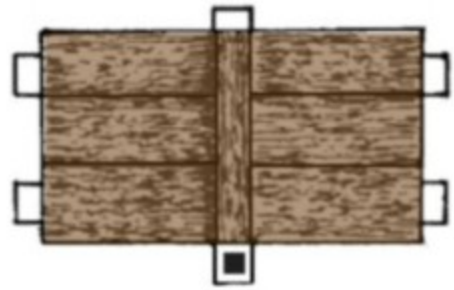

②上部井戸枠(外側)

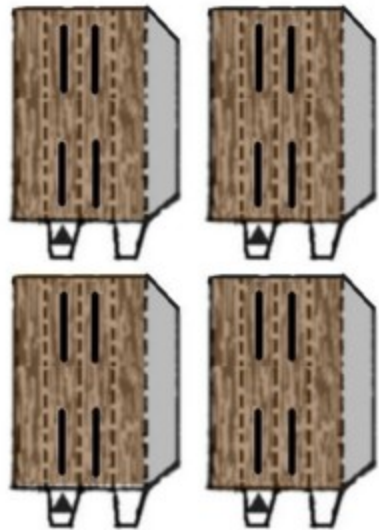

④上部井戸枠柱

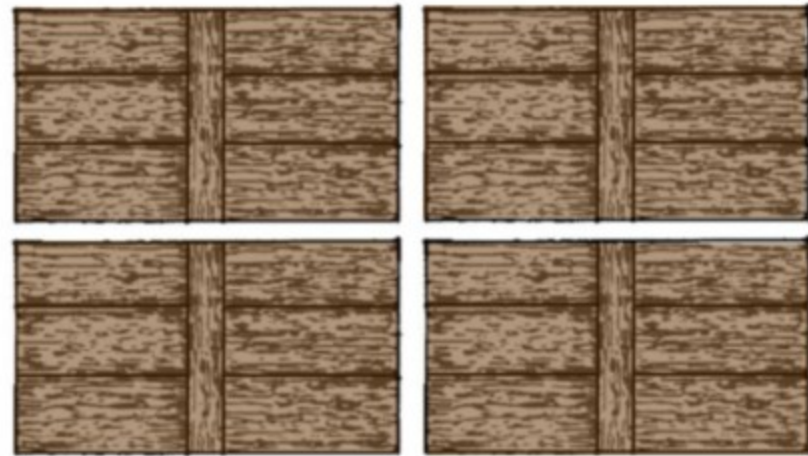

③上部井戸枠(内側)

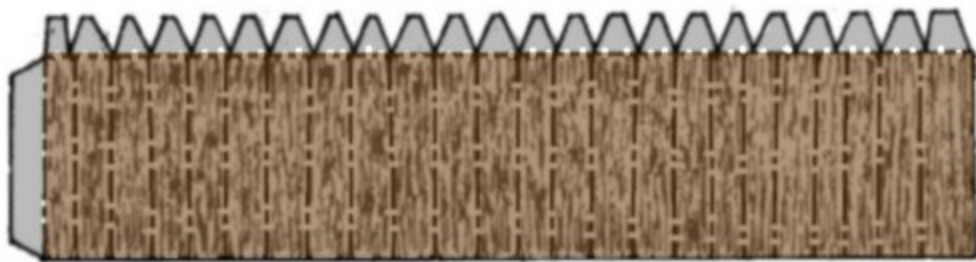

⑤下部井戸枠



⑫網

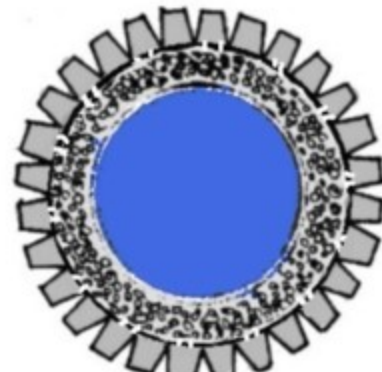

⑥下部井戸枠底

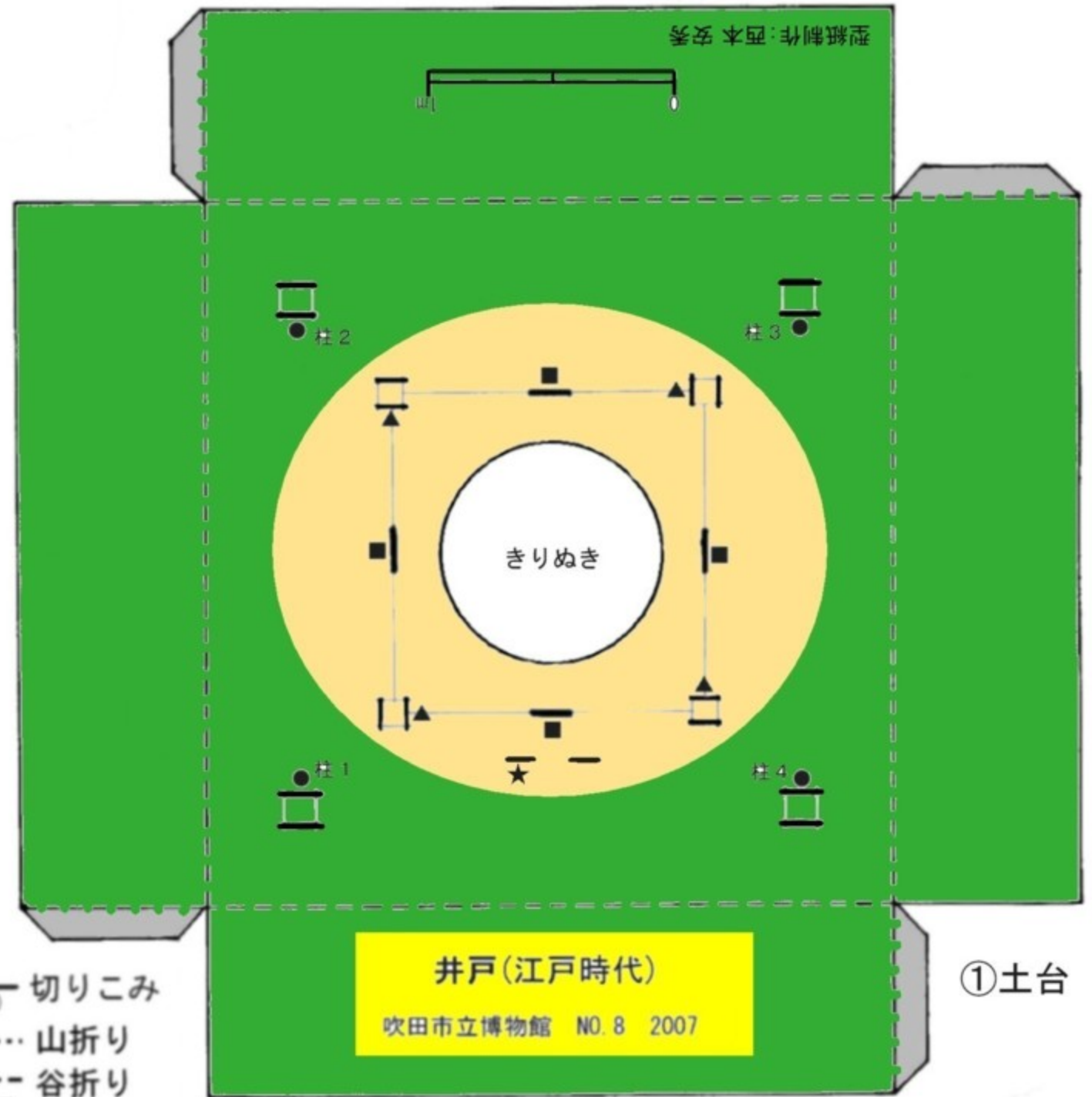

①土台

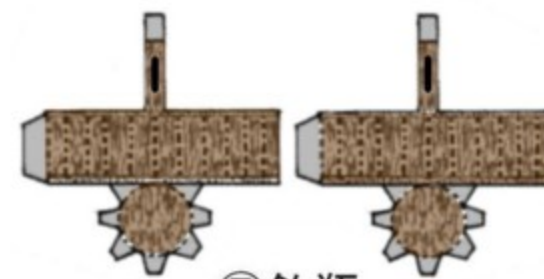

⑦釣瓶



⑨滑車部品 2

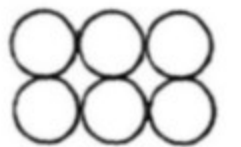

⑧滑車部品 1



⑩滑車部品 3



⑪滑車部品 4

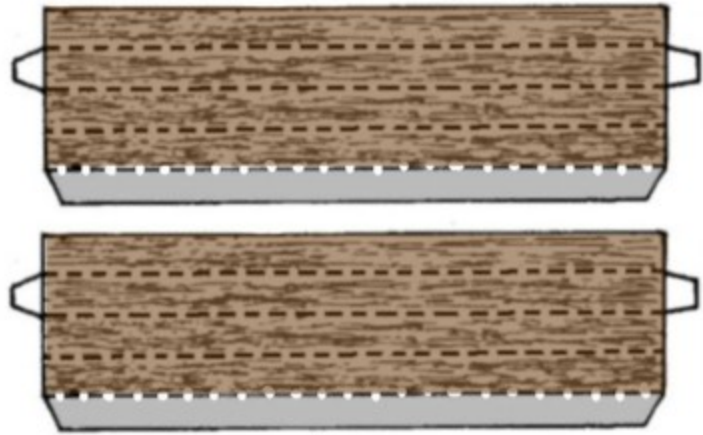

⑬ 桁

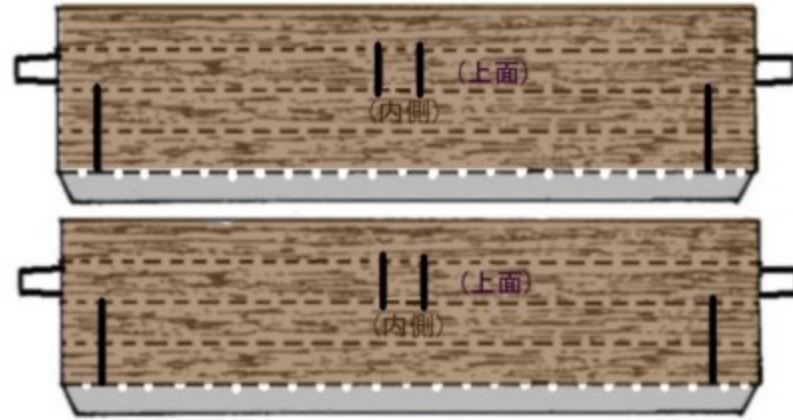

⑰ 梁

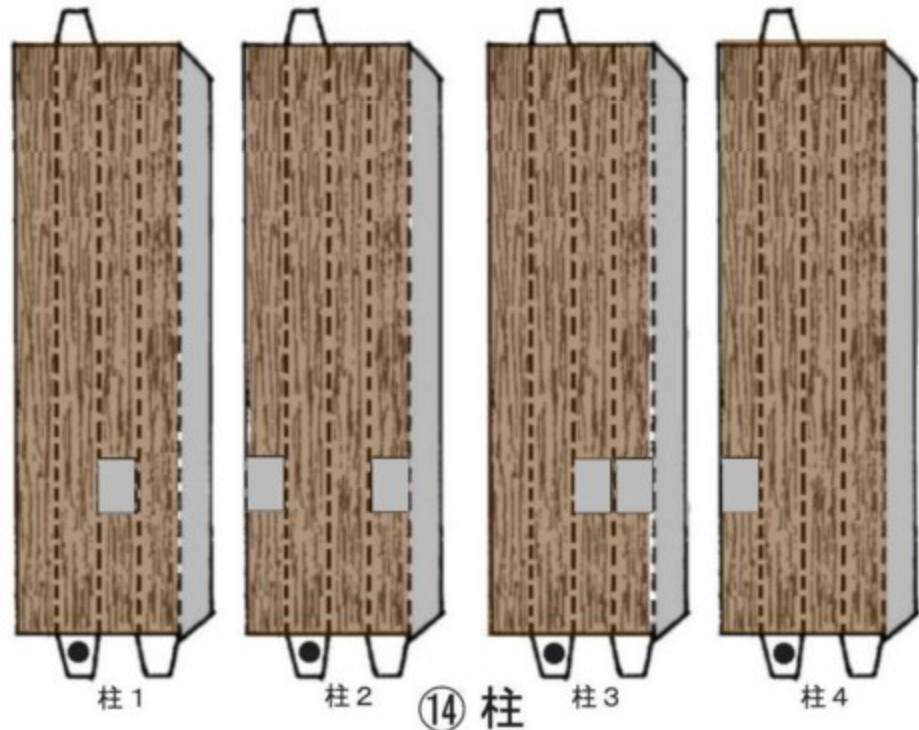

⑭ 柱

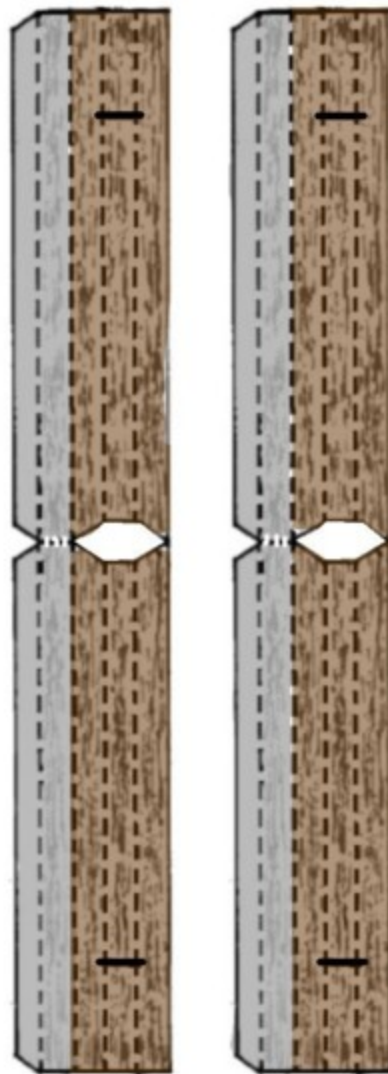

⑯ 垂木

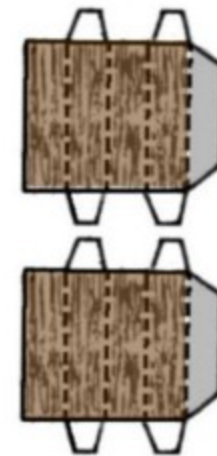

⑱ 束

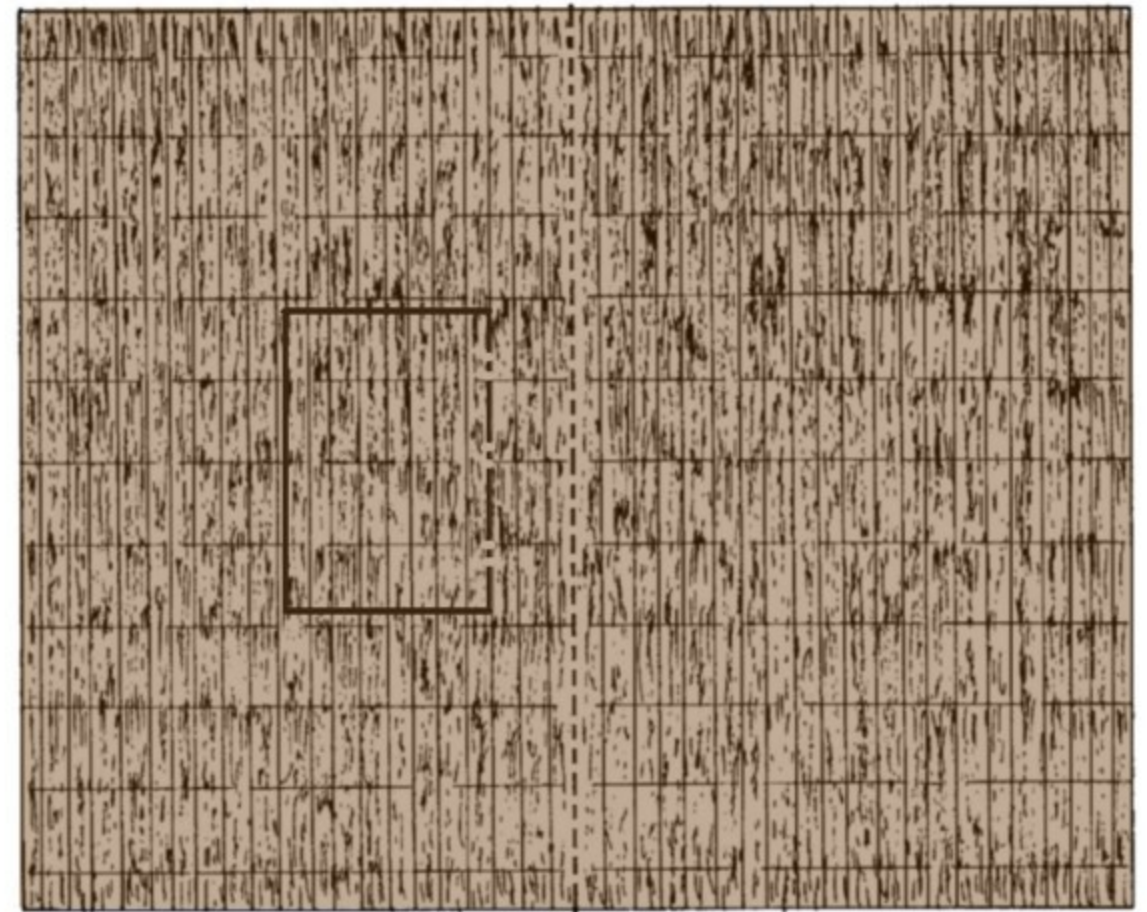

⑲ 屋根

- (太線) 切りこみ
- - - 山折り
- · - 谷折り
- のりづけ



⑳ 横木

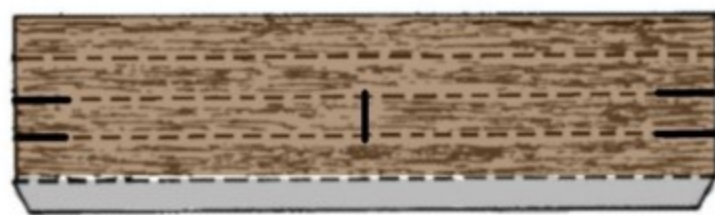

⑮ 棟木

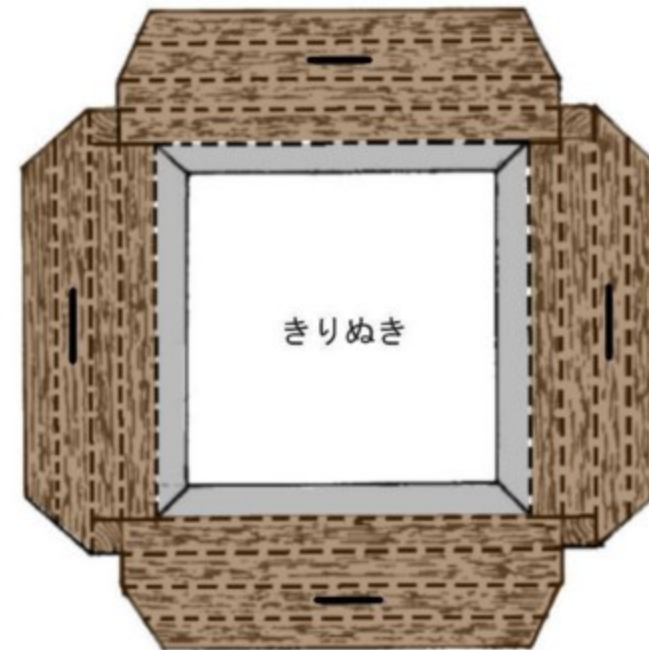

㉑ 上部井戸枠上板



㉒ 人物

井戸の組み立て方 1 吹田市立博物館 NO.8 2007

<1 各部品をつくる> ※各部品にきりこみを入れてからきりぬく。

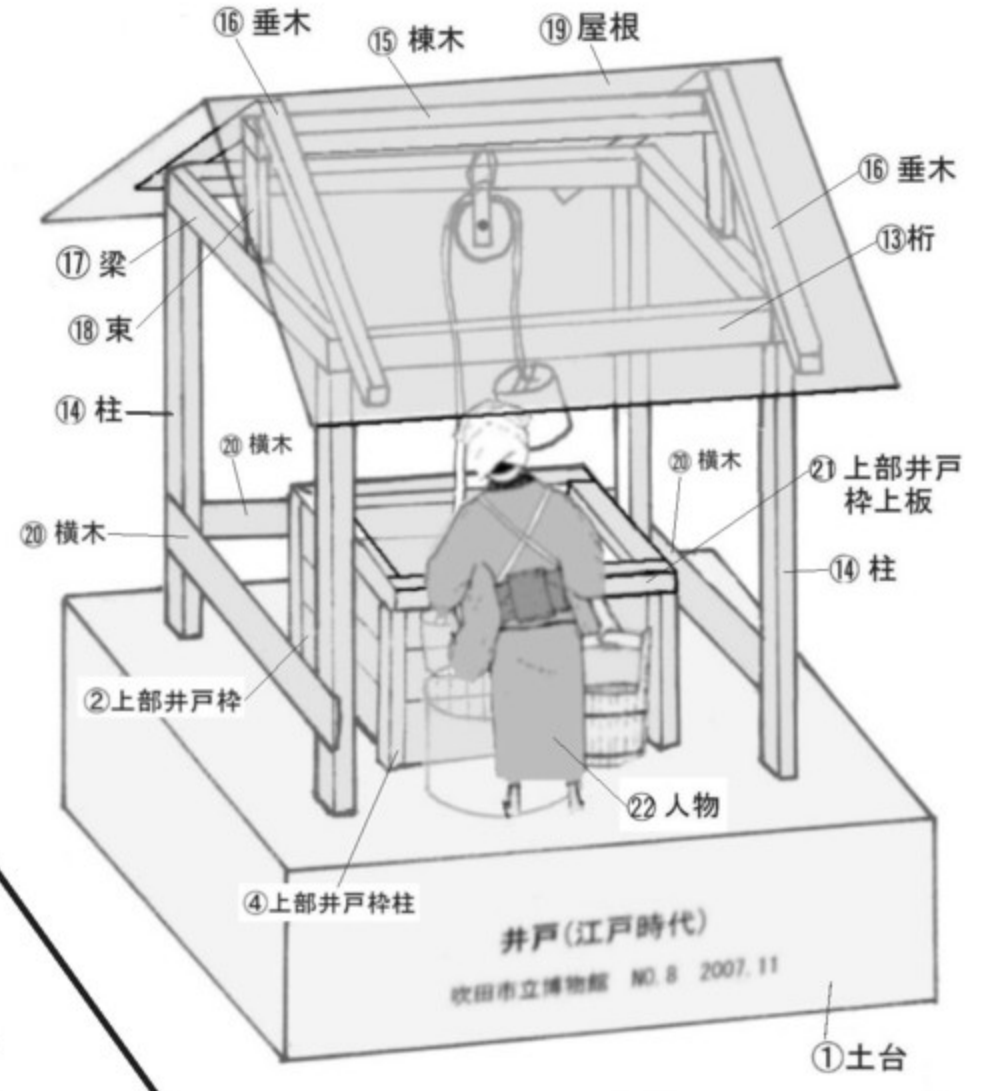
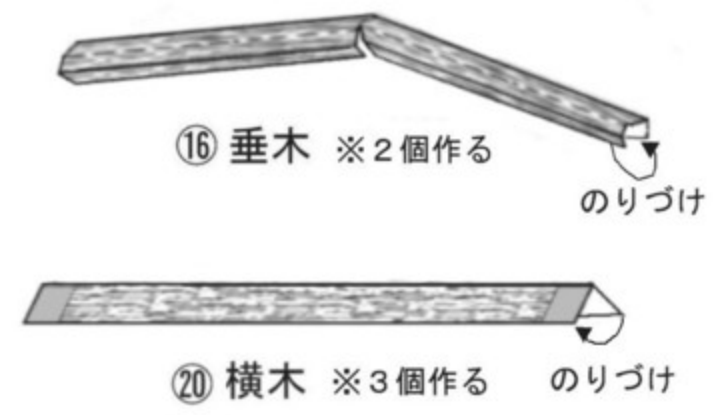
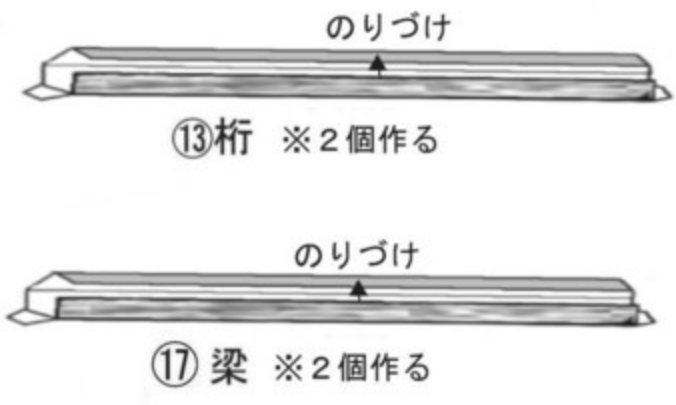
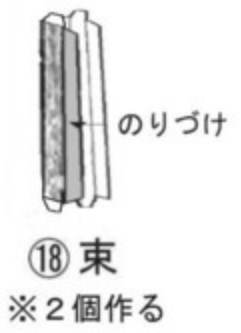
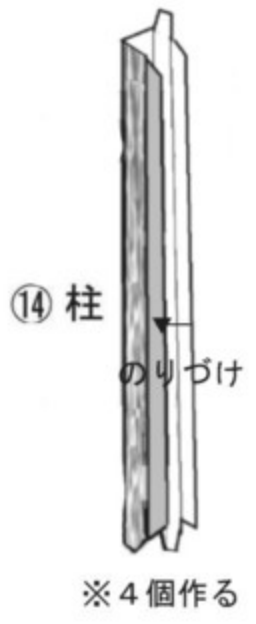
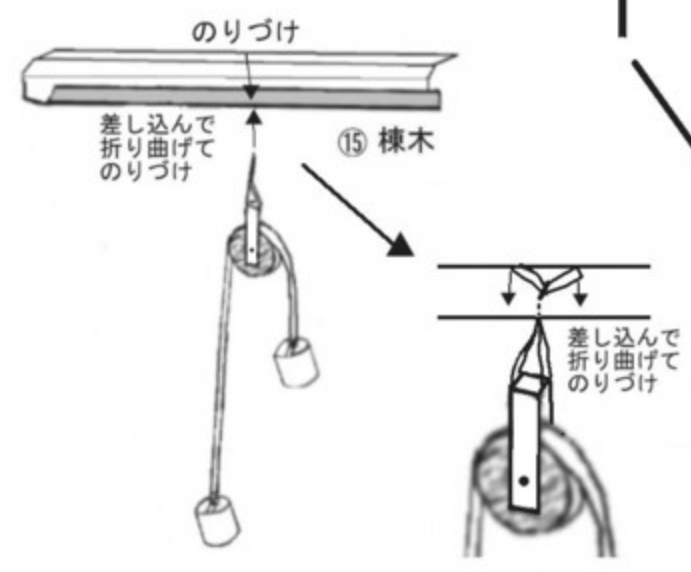
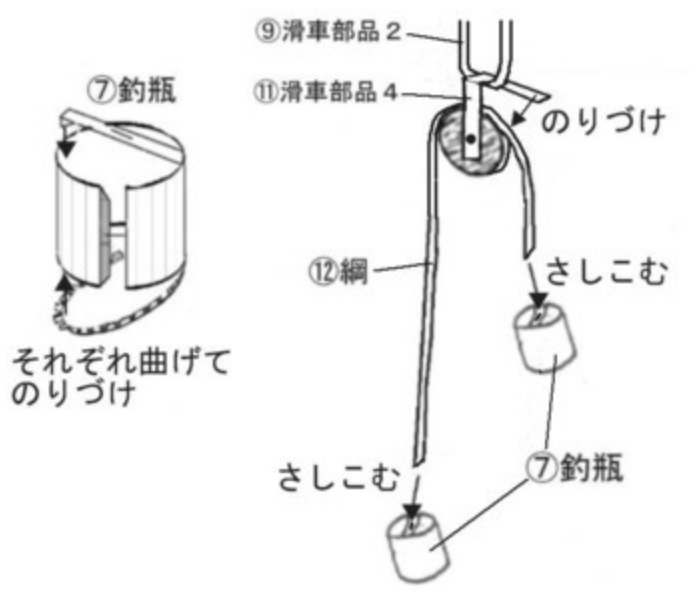
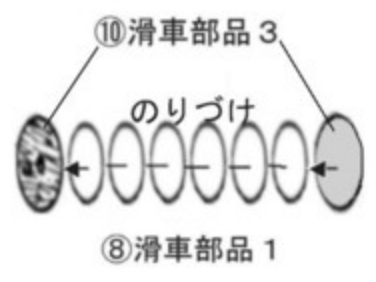
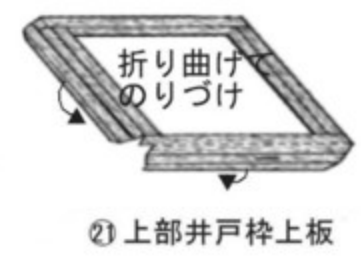
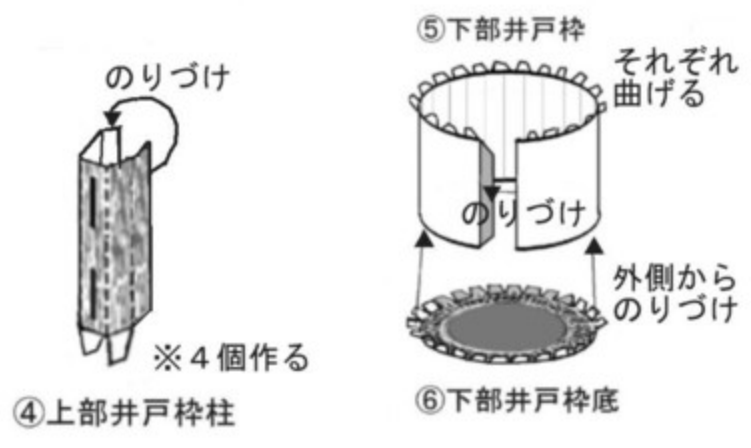
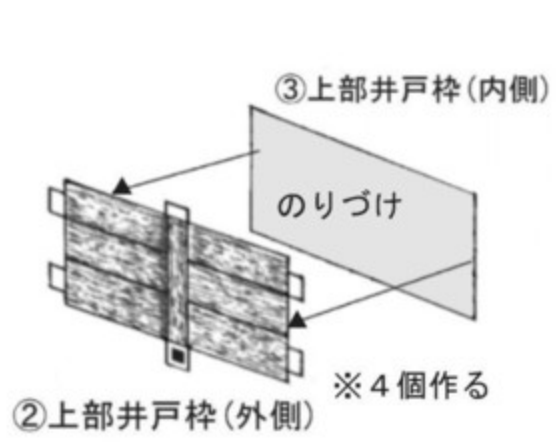

組み立て完成図

井戸(江戸時代)
吹田市立博物館 NO.8 2007.11

井戸の組み立て方 2

吹田市立博物館 NO.8 2007

<2 部品を組み立てる>

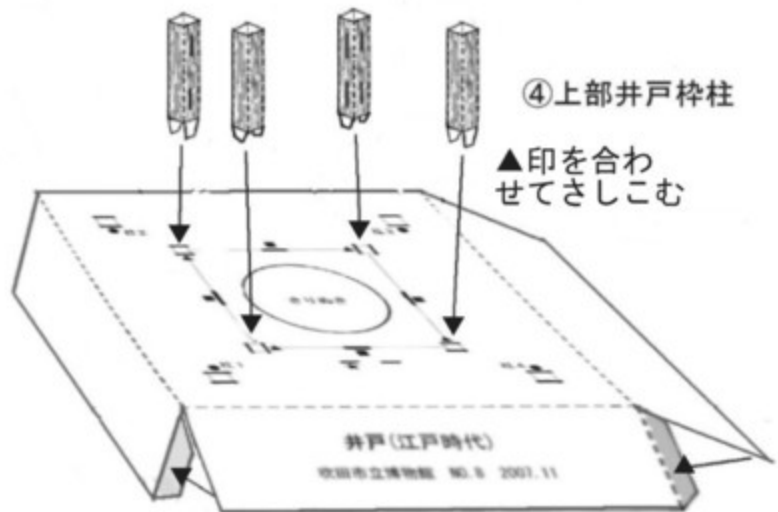

<1> のりづけ ①土台 のりづけ
①土台を組み立て、④上部井戸枠柱をさしこむ。

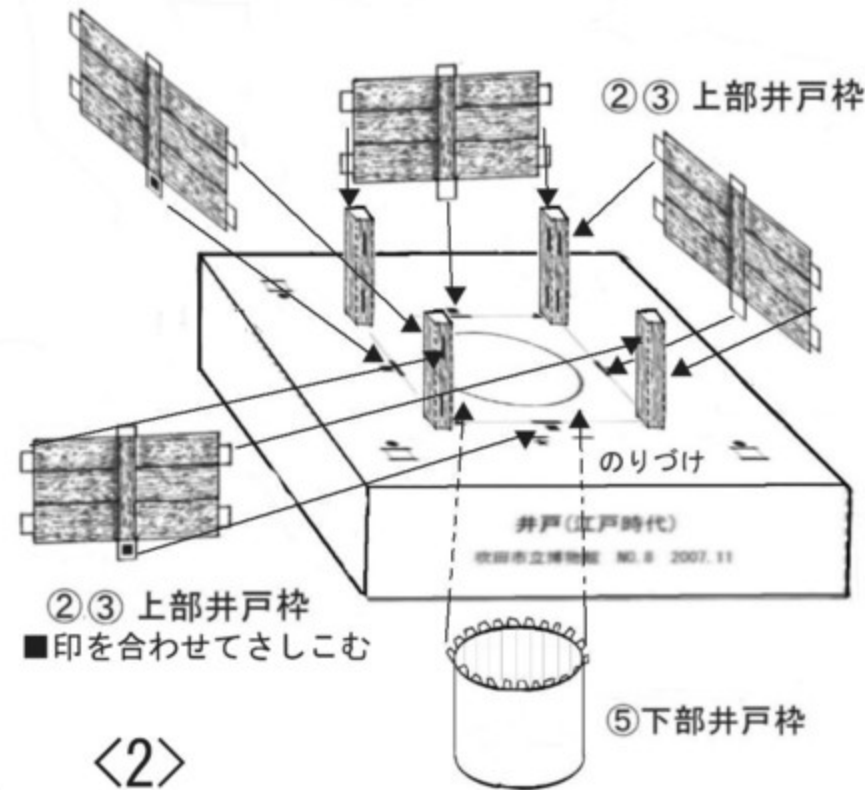

<2>
②③上部井戸枠をさしこみ、⑤下部井戸枠をのりづけする。

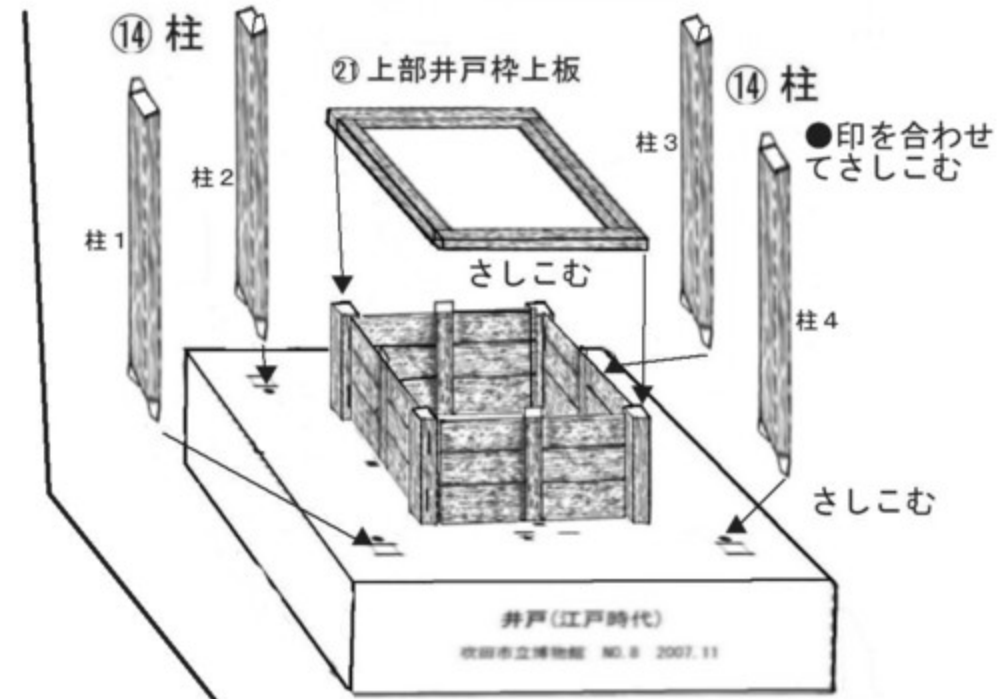

<3>
⑭柱、⑳上部井戸枠上板をさしこむ。

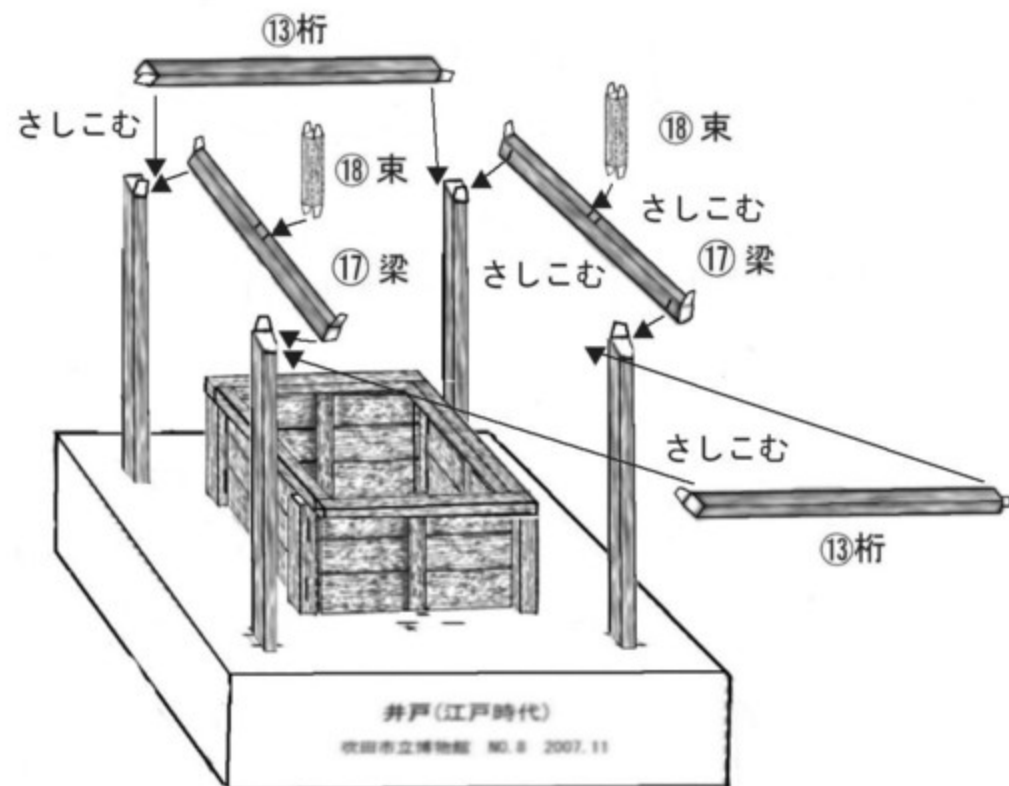

<4> ⑰梁、⑬桁、⑱束の順にさしこむ。

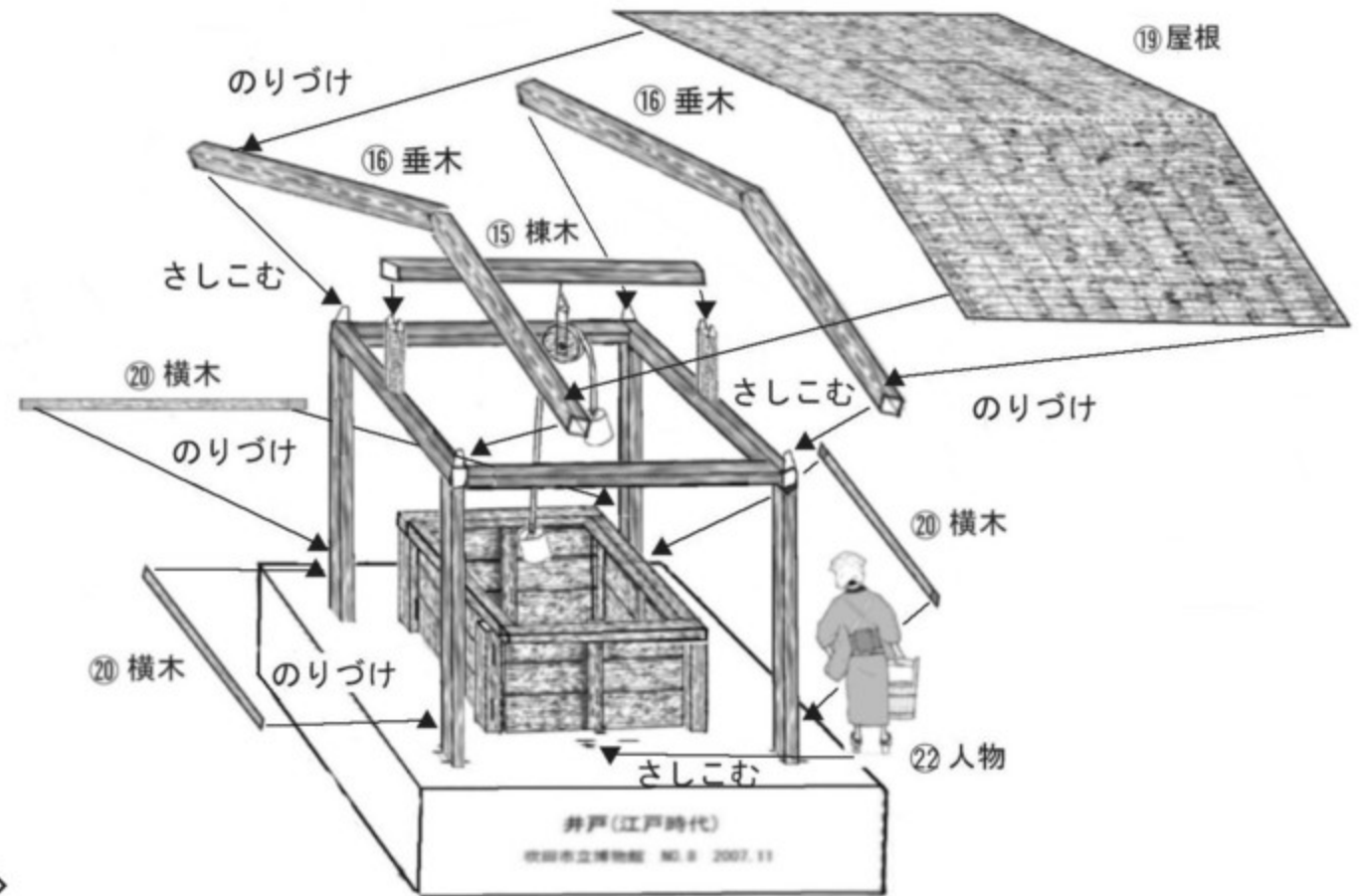

<5>
⑮棟木、⑯垂木の順にさしこみ、⑲屋根、⑳横木をのりづけする。最後に㉒人物をさしこむ。